

# KRA 3" LED

REMODEL ADJUSTABLE DOWNLIGHT & WALL WASH

The KRA 3" remodel adjustable LED downlight offers a cost-effective alternative to meet residential and commercial specifications on budget-sensitive projects. Custom engineered for high performance and reliability, KRA is easy to configure with a complete feature set that offers flexibility without an overwhelming list of options. KRA LED modules are available in High or Low Output, with 4 color temperatures and include 20°, 40° and 65° interchangeable optics with hot-aiming (30° tilt; 359° rotation). Flanged or flangeless (includes mud plate), round or square, flat or beveled die-cast trims in Silver and a paintable White finish.

- Hot-aiming (30° tilt; 359° rotation)
- Flanged or Flangeless Ceiling Appearance
- 20°, 40° and 65° interchangeable optics (all included)
- Accepts 2 optical controls
- 3-step color binning

## SPECIFICATIONS

|                     | HIGH OUTPUT   | LOW OUTPUT |
|---------------------|---|------------|
| DELIVERED LUMENS    | 1311  | 980        |
| WATTS               | 18  | 12         |
| EFFICACY            | 73  | 82         |
| CRI                 | 90  |            |
| CBCP (AT 3000K)     | 20° - 4994<br>40° - 2544<br>65° - 1091 (High Output)                                    |            |
| CCT OPTIONS         | 2700K, 3000K, 3500K, 4000K  |            |
| COLOR CONSISTENCY   | 3-Step  |            |
| VOLTAGE             | Universal 120V - 277V   |            |
| DIMMING*            | TRIAC, ELV or 0-10V (all standard, down to 5%)  |            |
| POWER SUPPLY        | Constant current driver with +.9 power factor and >87% efficiency                       |            |
| OPTICS              | 20°, 40°, 65° (all included)  |            |
| ADJUSTABILITY       | 0-30° tilt, 359° rotation   |            |
| CEILING APPEARANCE  | Flanged or Flangeless (Both accommodate 1/2" to 1" ceiling thickness)                   |            |
| CEILING APERTURE    | 4" ceiling cut-out  |            |
| HOUSING             | Non-IC  |            |
| CONSTRUCTION        | Trims: Die cast aluminum  |            |
| FINISH              | Housing: Black powder coat<br>Trims: Silver, White (paintable)                          |            |
| GENERAL LISTING     | ETL listed. Damp listed. Shower version wet listed. Energy Star.                        |            |
| CALIFORNIA TITLE 24 | Registered CEC Appliance Database. Can be used to comply with CEC 2016 Title 24 Part 6. |            |
| LED LIFETIME        | L70; 50,000 hours   |            |
| WARRANTY**          | 5 years   |            |



3" remodel adjustable

## TRIMS

### ROUND

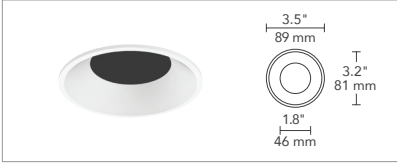

FLANGELESS BEVEL

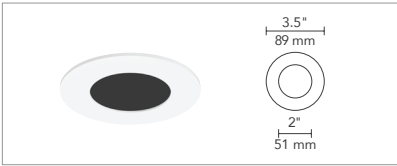

FLANGELESS FLAT

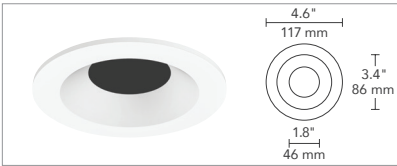

FLANGED BEVEL

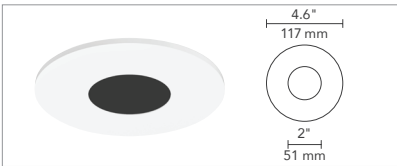

FLANGED FLAT

### SQUARE

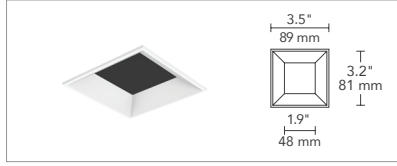

FLANGELESS BEVEL

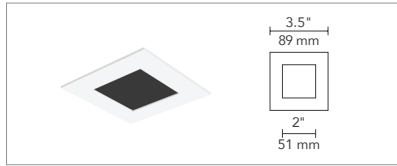

FLANGELESS FLAT

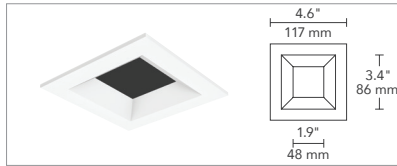

FLANGED BEVEL

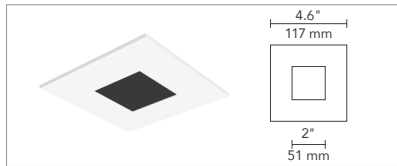

FLANGED FLAT

### WALL WASH



FLANGELESS WALL WASH



FLANGED WALL WASH

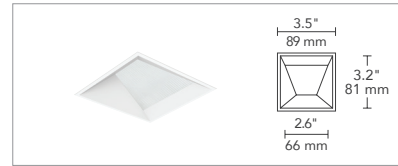

FLANGELESS WALL WASH



FLANGED WALL WASH

### FINISH



SILVER



WHITE (PAINTABLE)

## 3" MECHANISM\*

ROUND - SHOWN WITH SHORT COLLAR \*\*

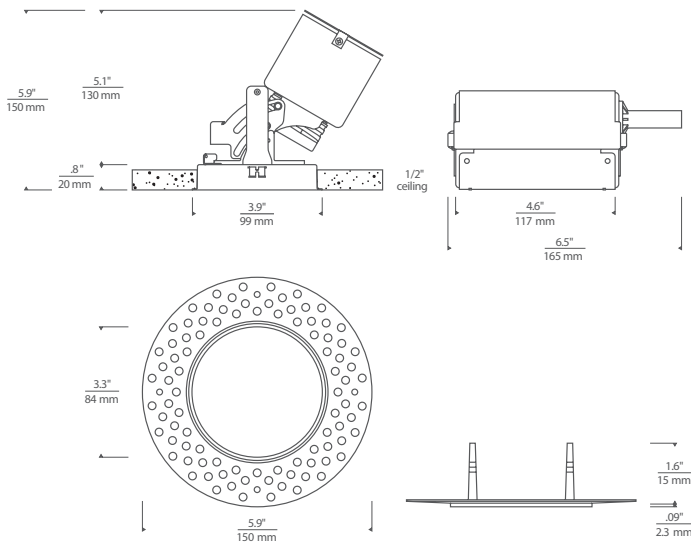

\*SHIPS WITH MUD/PLASTER PLATE FOR FLANGELESS INSTALLATION  
\*\*ACCOMMODATES 1/2" - 5/8" CEILING HEIGHTS

SQUARE - SHOWN WITH TALL COLLAR \*\*

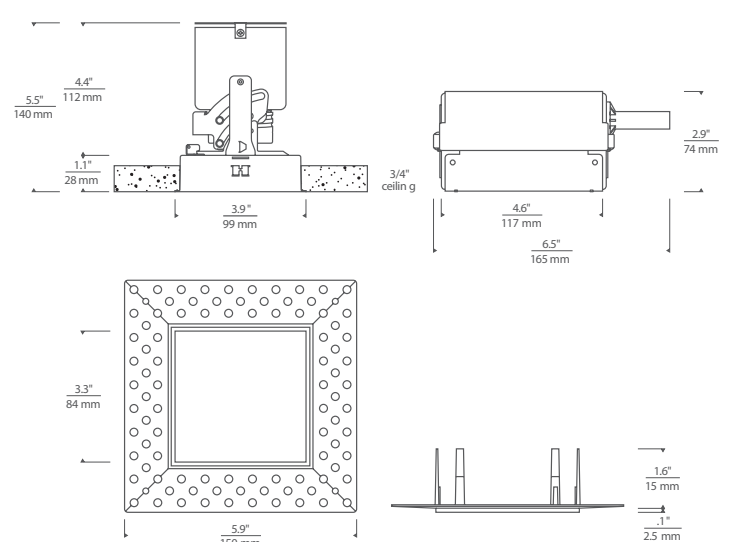

\*SHIPS WITH MUD/PLASTER PLATE FOR FLANGELESS INSTALLATION  
\*\*ACCOMMODATES 3/4" - 1" CEILING HEIGHTS

# KRA 3" LED

REMODEL ADJUSTABLE DOWNLIGHT & WALL WASH

## GRIDS

### HOUSING

| PRODUCT SERIES        | LAMP            | CRI      | TEMPERATURE | BEAM                | FUNCTION      | HOUSING RATING | VOLTAGE                |
|-----------------------|-----------------|----------|-------------|---------------------|---------------|----------------|------------------------|
| KRA 3" ROUND REMODEL  | -LH HIGH OUTPUT | 9 90 CRI | 27 2700K    | A 20° - 40° - 65° † | A ADJUSTABLE* | N NON-IC       | 120 VOLT (LEAVE BLANK) |
| KRA 3" SQUARE REMODEL | -LO LOW OUTPUT  |          | 30 3000K    |                     |               |                | -277 277 VOLT          |
|                       |                 |          | 35 3500K    |                     |               |                |                        |
|                       |                 |          | 40 4000K    |                     |               |                |                        |
|                       |                 | 9        | A           |                     | A             | N              |                        |

INCLUDES AN LED DRIVER THAT IS DIMMABLE BY TRIAC, ELV OR 0-10V CONTROLS.  
 HOUSING SHIPS WITH PLASTER-PLATE FOR USE ON FLANGELESS INSTALLATION, DO NOT USE PLATE FOR FLANGED INSTALLS.  
 TRIMS ARE REQUIRED AND MUST BE ORDERED SEPARATELY.  
 \*ADJUST TO 30° TILT FOR WALL WASH APPLICATION.  
 †LED MODULE SHIPS WITH 40° OPTIC INSTALLED. INCLUDES 20° AND 65° OPTICS AS WELL.

### TRIM

| PRODUCT SERIES | CEILING APPEARANCE | STYLE       | APERTURE                | FINISH   |
|----------------|--------------------|-------------|-------------------------|----------|
| KRA 3" ROUND   | L FLANGELESS       | B BEVEL     | -O NO LENS              | S SILVER |
| KRA 3" SQUARE  | F FLANGED          | F FLAT      | -H SHOWER (LENSED)*     | W WHITE  |
|                |                    | W WALL WASH | -W WALL WASH (LENSED)** |          |
| -              |                    |             |                         |          |

\*SHOWER (LENSED) APERTURE (-H) REQUIRES BEVEL TRIM (B).  
 \*\*WALL WASH STYLE TRIM (W) CAN ONLY BE USED WITH WALL WASH LENSED APERTURE (-W).

### LENSES/LOUVERS

| ITEM      | DESCRIPTION          |
|-----------|----------------------|
| 140MR16SF | SOLITE ROUND LENS    |
| 140MR16SB | SANDBLASTED LENS     |
| 140MR16LL | LINEAR SPREAD LENS   |
| 140MR16DF | DIFFUSER SPREAD LENS |
| 140MR16GL | CLEAR LENS           |
| 700A02-BK | EGGCRATE LOUVER      |

## PROJECT INFO

| FIXTURE TYPE & QUANTITY | JOB NAME & INFO | NOTES |
|-------------------------|-----------------|-------|
|                         |                 |       |
|                         |                 |       |

## PHOTOMETRICS: 3" LED

DESCRIPTION : 3" LED Module  
20° Beam - 0° Tilt, 3000K  
MODEL: KRA Adjustable 20° Low Output

INPUT POWER (WATTS): 11.9  
INPUT POWER FACTOR: 0.98  
ABSOLUTE LUMINOUS FLUX (LUMENS): 950  
LUMEN EFFICACY (LUMENS PER WATT): 80

| ANGLE | 0°   | 45°  | 90°  |
|-------|------|------|------|
| 0°    | 4213 | 4213 | 4213 |
| 5°    | 3746 | 3797 | 3620 |
| 10°   | 2524 | 2562 | 2359 |
| 15°   | 1429 | 1454 | 1292 |
| 20°   | 770  | 786  | 670  |
| 25°   | 435  | 439  | 358  |
| 30°   | 252  | 251  | 192  |
| 35°   | 132  | 136  | 99   |
| 40°   | 65   | 71   | 51   |
| 45°   | 30   | 38   | 24   |
| 50°   | 11   | 20   | 9    |
| 55°   | 5    | 9    | 4    |
| 60°   | 2    | 3    | 2    |
| 65°   | 1    | 1    | 1    |
| 70°   | 0    | 1    | 0    |
| 75°   | 0    | 0    | 0    |
| 80°   | 0    | 0    | 0    |
| 85°   | 0    | 0    | 0    |
| 90°   | 0    | 0    | 0    |

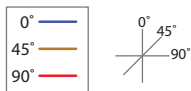
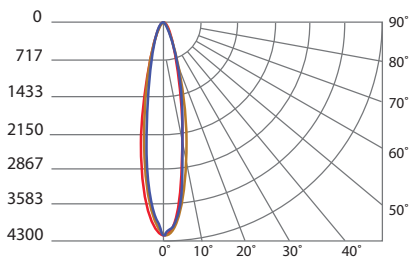
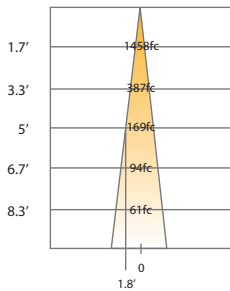

DESCRIPTION : 3" LED Module  
40° Beam - 0° Tilt, 3000K  
MODEL: KRA Adjustable 40° Low Output

INPUT POWER (WATTS): 11.9  
INPUT POWER FACTOR: 0.98  
ABSOLUTE LUMINOUS FLUX (LUMENS): 979  
LUMEN EFFICACY (LUMENS PER WATT): 82

| ANGLE | 0°   | 45°  | 90°  |
|-------|------|------|------|
| 0°    | 1822 | 1822 | 1822 |
| 5°    | 1771 | 1762 | 1770 |
| 10°   | 1624 | 1614 | 1588 |
| 15°   | 1413 | 1375 | 1289 |
| 20°   | 1130 | 1050 | 916  |
| 25°   | 795  | 700  | 562  |
| 30°   | 486  | 422  | 323  |
| 35°   | 267  | 242  | 175  |
| 40°   | 120  | 131  | 81   |
| 45°   | 49   | 65   | 33   |
| 50°   | 21   | 29   | 14   |
| 55°   | 10   | 10   | 7    |
| 60°   | 3    | 4    | 2    |
| 65°   | 0    | 2    | 0    |
| 70°   | 0    | 0    | 0    |
| 75°   | 0    | 0    | 0    |
| 80°   | 0    | 0    | 0    |
| 85°   | 0    | 0    | 0    |
| 90°   | 0    | 0    | 0    |

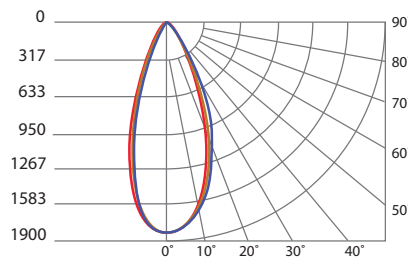
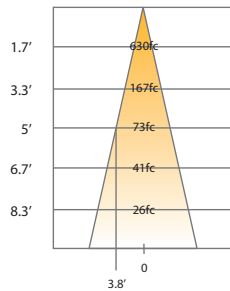

DESCRIPTION : 3" LED Module  
65° Beam - 0° Tilt, 3000K  
MODEL: KRA Adjustable 65° Low Output

INPUT POWER (WATTS): 11.9  
INPUT POWER FACTOR: 0.98  
ABSOLUTE LUMINOUS FLUX (LUMENS): 1022  
LUMEN EFFICACY (LUMENS PER WATT): 86

| ANGLE | 0°  | 45° | 90° |
|-------|-----|-----|-----|
| 0°    | 691 | 691 | 691 |
| 5°    | 701 | 691 | 680 |
| 10°   | 703 | 696 | 677 |
| 15°   | 708 | 707 | 686 |
| 20°   | 698 | 706 | 683 |
| 25°   | 658 | 667 | 647 |
| 30°   | 568 | 580 | 563 |
| 35°   | 436 | 449 | 436 |
| 40°   | 275 | 296 | 285 |
| 45°   | 145 | 161 | 150 |
| 50°   | 68  | 72  | 67  |
| 55°   | 28  | 30  | 28  |
| 60°   | 3   | 13  | 5   |
| 65°   | 0   | 3   | 0   |
| 70°   | 0   | 0   | 0   |
| 75°   | 0   | 0   | 0   |
| 80°   | 0   | 0   | 0   |
| 85°   | 0   | 0   | 0   |
| 90°   | 0   | 0   | 0   |

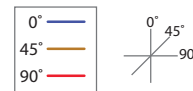
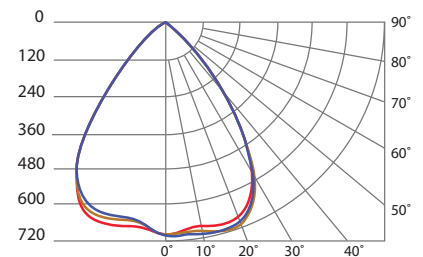
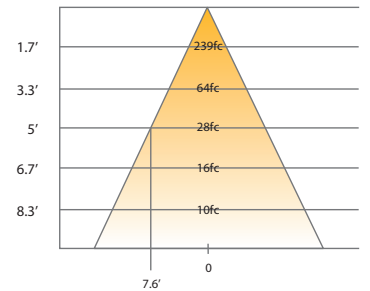

## PHOTOMETRICS: 3" LED

DESCRIPTION : 3" LED Module  
20° Beam - 0° Tilt, 3000K  
MODEL: KRA Adjustable 20° High Output

INPUT POWER (WATTS): 18.3  
INPUT POWER FACTOR: 0.99  
ABSOLUTE LUMINOUS FLUX (LUMENS): 1311.9  
LUMEN EFFICACY (LUMENS PER WATT): 71.4

| ANGLE | 0°   | 45°  | 90°  |
|-------|------|------|------|
| 0°    | 4994 | 4994 | 4994 |
| 5°    | 4241 | 4230 | 4370 |
| 10°   | 2808 | 2800 | 2940 |
| 15°   | 1686 | 1670 | 1736 |
| 20°   | 981  | 677  | 982  |
| 25°   | 570  | 564  | 546  |
| 30°   | 315  | 314  | 291  |
| 35°   | 176  | 178  | 161  |
| 40°   | 99   | 102  | 93   |
| 45°   | 56   | 60   | 53   |
| 50°   | 30   | 36   | 28   |
| 55°   | 17   | 20   | 16   |
| 60°   | 8    | 10   | 8    |
| 65°   | 2    | 5    | 1    |
| 70°   | 1    | 1    | 1    |
| 75°   | 1    | 1    | 1    |
| 80°   | 0    | 0    | 0    |
| 85°   | 0    | 0    | 0    |
| 90°   | 0    | 0    | 0    |

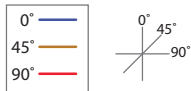
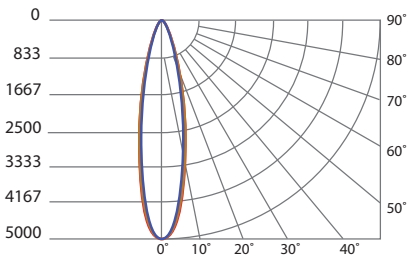
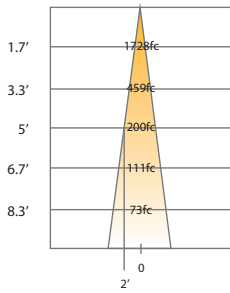

DESCRIPTION : 3" LED Module  
40° Beam - 0° Tilt, 3000K  
MODEL: KRA Adjustable 40° High Output

INPUT POWER (WATTS): 18.3  
INPUT POWER FACTOR: 0.99  
ABSOLUTE LUMINOUS FLUX (LUMENS): 1306.1  
LUMEN EFFICACY (LUMENS PER WATT): 71.1

| ANGLE | 0°   | 45°  | 90°  |
|-------|------|------|------|
| 0°    | 2544 | 2544 | 2544 |
| 5°    | 2550 | 2468 | 2426 |
| 10°   | 2299 | 2200 | 2134 |
| 15°   | 1893 | 1795 | 1711 |
| 20°   | 1406 | 1312 | 1217 |
| 25°   | 908  | 840  | 763  |
| 30°   | 528  | 492  | 440  |
| 35°   | 294  | 283  | 248  |
| 40°   | 155  | 163  | 136  |
| 45°   | 83   | 93   | 72   |
| 50°   | 46   | 52   | 40   |
| 55°   | 25   | 28   | 22   |
| 60°   | 10   | 15   | 8    |
| 65°   | 1    | 6    | 1    |
| 70°   | 1    | 1    | 1    |
| 75°   | 0    | 0    | 1    |
| 80°   | 0    | 0    | 0    |
| 85°   | 0    | 0    | 0    |
| 90°   | 0    | 0    | 0    |

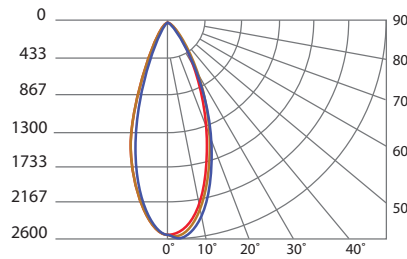
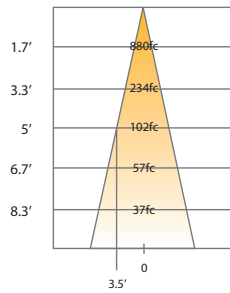

DESCRIPTION : 3" LED Module  
65° Beam - 0° Tilt, 3000K  
MODEL: KRA Adjustable 65° High Output

INPUT POWER (WATTS): 18.3  
INPUT POWER FACTOR: 0.99  
ABSOLUTE LUMINOUS FLUX (LUMENS): 1255  
LUMEN EFFICACY (LUMENS PER WATT): 68.4

| ANGLE | 0°   | 45°  | 90°  |
|-------|------|------|------|
| 0°    | 1091 | 1091 | 1091 |
| 5°    | 1076 | 1070 | 1086 |
| 10°   | 1036 | 1039 | 1058 |
| 15°   | 982  | 985  | 995  |
| 20°   | 910  | 907  | 899  |
| 25°   | 811  | 803  | 774  |
| 30°   | 682  | 674  | 624  |
| 35°   | 537  | 525  | 460  |
| 40°   | 373  | 366  | 302  |
| 45°   | 234  | 226  | 179  |
| 50°   | 134  | 126  | 100  |
| 55°   | 68   | 65   | 50   |
| 60°   | 14   | 34   | 8    |
| 65°   | 1    | 7    | 1    |
| 70°   | 0    | 1    | 1    |
| 75°   | 0    | 1    | 1    |
| 80°   | 0    | 0    | 0    |
| 85°   | 0    | 0    | 0    |
| 90°   | 0    | 0    | 0    |

