

DATE	PROJECT	FIRM	TYPE
------	---------	------	------

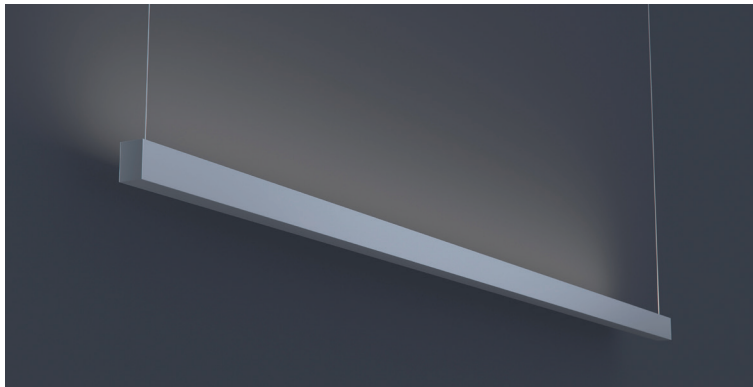

Architectural luminaire with extremely low profile. LED luminaire that provides continuous uplight regardless of length. Custom outputs and colors available.

**FEATURES**

- Available In Custom Lengths & Long Runs To 1/16" Accuracy
- Corners & Patterns Available (See Page 2)
- 100% Uplight
- Damp Location Rated
- CRI 90+ Standard
- 3000K & 3500K Color Temperatures Available

<b>APPLICATIONS</b>	Offices, Reception Areas & Corridors
---------------------	--------------------------------------

<b>CONSTRUCTION</b>	Extruded Aluminum Housing With Die Cast Aluminum End Caps	<b>OPTICS</b>	Acrylic Diffuse Lens
---------------------	---	---------------	----------------------

<b>WARRANTY</b>	5 Year Limited Warranty (Covers Standard Components)	<b>FINISH</b>	Standard Powder-Coated White. Custom RAL Colors Available
-----------------	--	---------------	---

<b>FIXTURE RATINGS &amp; CERTIFICATIONS</b>	Union Made ETL Listed	Made In The USA Damp Location Rated
---	--------------------------	--



<b>ELECTRICAL</b>	0-10V Remote Driver with 19% Dimming
-------------------	--------------------------------------

**EXTRUSION DIMENSIONS**

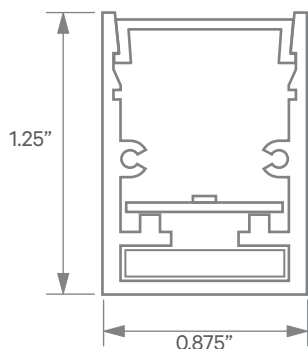

**LED SYSTEM INFORMATION**

	Nominal System Watts	Nominal Delivered Lumens
Standard (LTG1)	5.25 W/ft	445 Lm/ft
Low (LTG2)	3.5 W/ft	300 Lm/ft
High (LTG3)	7.25 W/ft	585 Lm/ft

Based on a 3500K luminaire using one driver. Please consult factory for custom lumen outputs & wattage.

**ORDERING**



<b>1 - FIXTURE ID</b> KUSH LED UP	<b>2 - LENGTH</b> 4 - 4 ft 8 - 8 ft x'-x" - Custom (specify length)  **Patterns available consult factory	<b>3 - COLOR TEMP</b> 27 - 2700K/90 CRI 30 - 3000K/90 CRI 35 - 3500K/90 CRI 40 - 4000K/90 CRI	<b>4 - LED SYSTEM</b> LTG1 - Standard LTG2 - Low LTG3 - High C - Custom Output (ie-C550Lm/ft)	<b>5 - VOLTAGE</b> UNV - Universal (120/277V)	<b>6 - DRIVER (Remote)</b> DB - Standard 10% Dimming (0-10V) DB1% - 1% Dimming (0-10V) LTEA - Lutron 2-wire 1% Dimming L3DA - Lutron 3-wire 1% Dimming LDE1 - Lutron Digital EcoSystem DMX - DMX Control
--------------------------------------	--	---	---	--	--

<b>7 - FINISH</b> W - White (Standard) CC - Custom Color (provide RAL#)	<b>8 - MOUNTING</b> AC - Aircraft Cable (50")	<b>9 - CIRCUIT (Optional)</b> EM 120V - Emergency Pack EM 277V - Emergency Pack
---	--	---

DATE	PROJECT	FIRM	TYPE
------	---------	------	------

**CORNERS & PATTERNS**

Available with illuminated corners, angles, and custom patterns. **Must consult factory for custom corners and patterns.**

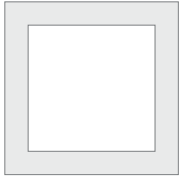

Square Patterns

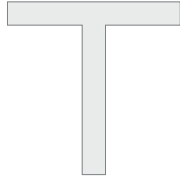

T Patterns

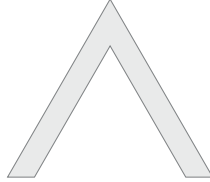

Custom Angles

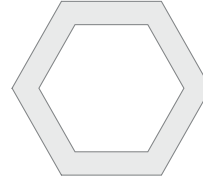

Custom Patterns

**LENS CUT OPTIONS**

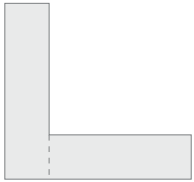

Straight-cut

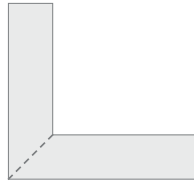

Mitered Angle

**NOTE:** Straight-Cut is standard configuration, Mitered Angle is optional and must be specified.

DATE	PROJECT	FIRM	TYPE
------	---------	------	------

PHOTOMETRICS

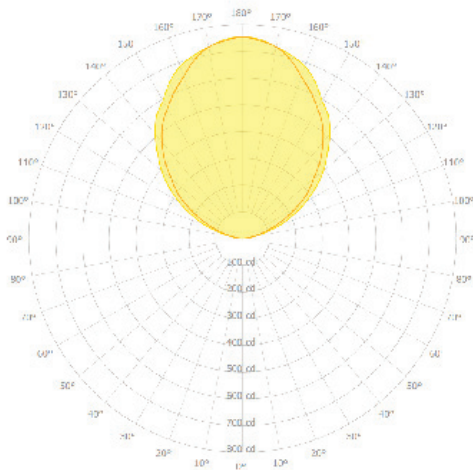

**KUSH LED UP 4FT LTG1 3500K**  
 DELIVERED LUMENS: 1,789Lm  
 TOTAL WATTS: 21W

ZONAL LUMEN SUMMARY

ZONE	LUMENS	% LAMP	% FIXTURE
0.00 - 30.00	0.00	0.00	0.00
0.00 - 40.00	0.00	0.00	0.00
0.00 - 60.00	0.00	0.00	0.00
0.00 - 90.00	0.30	0.01	0.02
90.00 - 120.00	294.47	9.32	16.45
90.00 - 150.00	1232.17	39.00	68.84
90.00 - 180.00	1789.67	56.64	99.98
0.00 - 180.00	1789.98	56.65	100.00

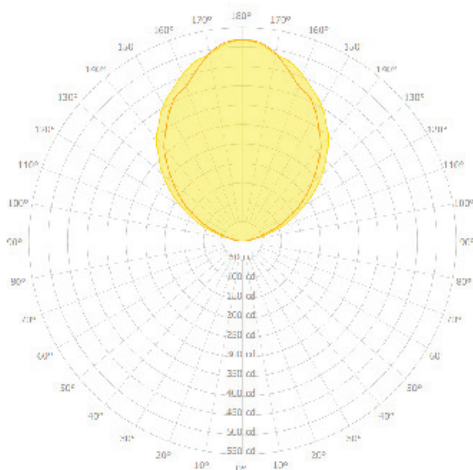

**KUSH LED UP 4FT LTG2 3500K**  
 DELIVERED LUMENS: 1,200Lm  
 TOTAL WATTS: 14W

ZONAL LUMEN SUMMARY

ZONE	LUMENS	% LAMP	% FIXTURE
0.00 - 30.00	0.00	0.00	0.00
0.00 - 40.00	0.00	0.00	0.00
0.00 - 60.00	0.00	0.00	0.00
0.00 - 90.00	0.20	0.01	0.02
90.00 - 120.00	197.73	9.33	16.47
90.00 - 150.00	826.78	39.03	68.87
90.00 - 180.00	1200.37	56.67	99.98
0.00 - 180.00	1200.58	56.68	100.00

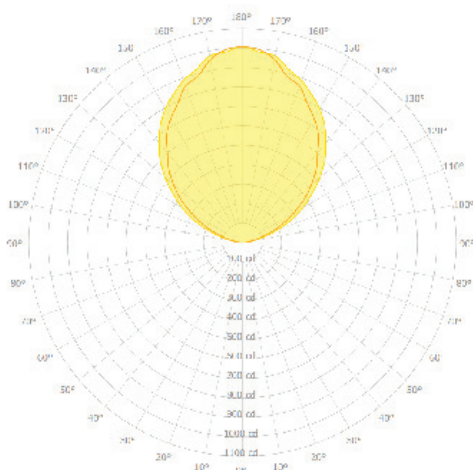

**KUSH LED UP 4FT LTG3 3500K**  
 DELIVERED LUMENS: 2,343Lm  
 TOTAL WATTS: 29W

ZONAL LUMEN SUMMARY

ZONE	LUMENS	% LAMP	% FIXTURE
0.00 - 30.00	0.00	0.00	0.00
0.00 - 40.00	0.00	0.00	0.00
0.00 - 60.00	0.00	0.00	0.00
0.00 - 90.00	0.40	0.01	0.02
90.00 - 120.00	385.24	9.31	16.44
90.00 - 150.00	1613.43	38.99	68.83
90.00 - 180.00	2343.58	56.63	99.98
0.00 - 180.00	2343.99	56.64	100.00